













B&W OUTDOOR.CASE TYPE 3000

Product number: 3000/O

	two eyelets for padlocks (Ø 0.3 inch)		dustproof
	waterproof (IP67 certified)		30-year warranty
	extremely robust		rubberized handle
	easy-open locks		stackable
	temperature stable		airworthy

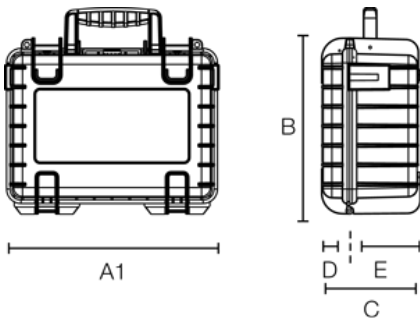

A (A1):	365 mm
B:	295 mm
C:	170 mm
A (A1) inside:	330 mm
B inside:	235 mm
C inside:	150 mm
D (lid) inside:	40 mm
E (bottom) inside:	110 mm

Product features

Possible configurations	empty pre-cut foam (SI) padded dividers (RPD)
Certificates	UN 3090/91 UN 3480/81 ATA 300 MIL-STD-801G IP67 STANAG 4280 DEF STAN 81-41
Material	PP
Volume (l)	11.7

Accessories

Lid Pocket (LP) for B&W outdoor.case
Shoulder Strap (CS) for B&W outdoor.case
Mesh bag (MB) for B&W outdoor.cases