













## B&W OUTDOOR.CASE TYP 2000

Product number: 2000/Y

	two eyelets for padlocks (Ø 0.2 inch)		dustproof
	waterproof (IP67 certified)		30-year warranty
	extremely robust		rubberized handle
	easy-open locks		stackable
	temperature stable		airworthy

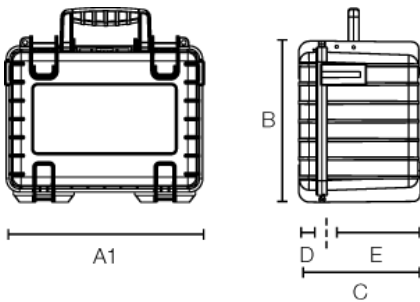

A (A1):	<b>270 mm</b>
B:	<b>215 mm</b>
C:	<b>165 mm</b>
A (A1) inside:	<b>250 mm</b>
B inside:	<b>175 mm</b>
C inside:	<b>155 mm</b>
D (lid) inside:	<b>25 mm</b>
E (bottom) inside:	<b>130 mm</b>

### Product features

Possible configurations	empty pre-cut foam (SI) padded dividers (RPD)
Certificates	UN 3090/91 UN 3480/81 ATA 300 MIL-STD-801G IP67 STANAG 4280 DEF STAN 81-41
Material	PP
Volume (l)	6.6

### Accessories

Lid Pocket (LP) for B&W outdoor.case
Shoulder Strap (CS) for B&W outdoor.case
Mesh bag (MB) for B&W outdoor.cases