











TYPE 2000 DJI MINI4 PRO

Product number: PP.66.BG.Mini4



- | | | | |
|---|---------------------------------------|---|-------------------|
|  | two eyelets for padlocks (Ø 0.2 inch) |  | dustproof |
|  | temperature stable |  | 30-year warranty |
|  | telescopic handle |  | airworthy |
|  | stackable |  | rubberized handle |
|  | waterproof (IP67 certified) |  | extremely robust |

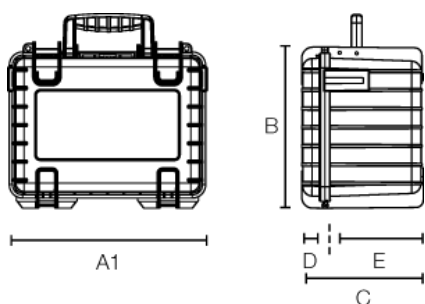

A (A1):	270 mm
B:	215 mm
C:	165 mm
A (A1) inside:	250 mm
B inside:	175 mm
C inside:	155 mm
D (lid) inside:	25 mm
E (bottom) inside:	130 mm

Product features

Use	Drone
Certificates	DEF STAN 81-41 STANAG 4280 ATA 300 IP67 MIL-STD-801G UN 3090/91 UN 3480/81
Material	PP
Volume (l)	6.6

Accessories

- Lid Pocket (LP) for B&W outdoor.case
- Shoulder Strap (CS) for B&W outdoor.case
- Mesh bag (MB) for B&W outdoor.cases